

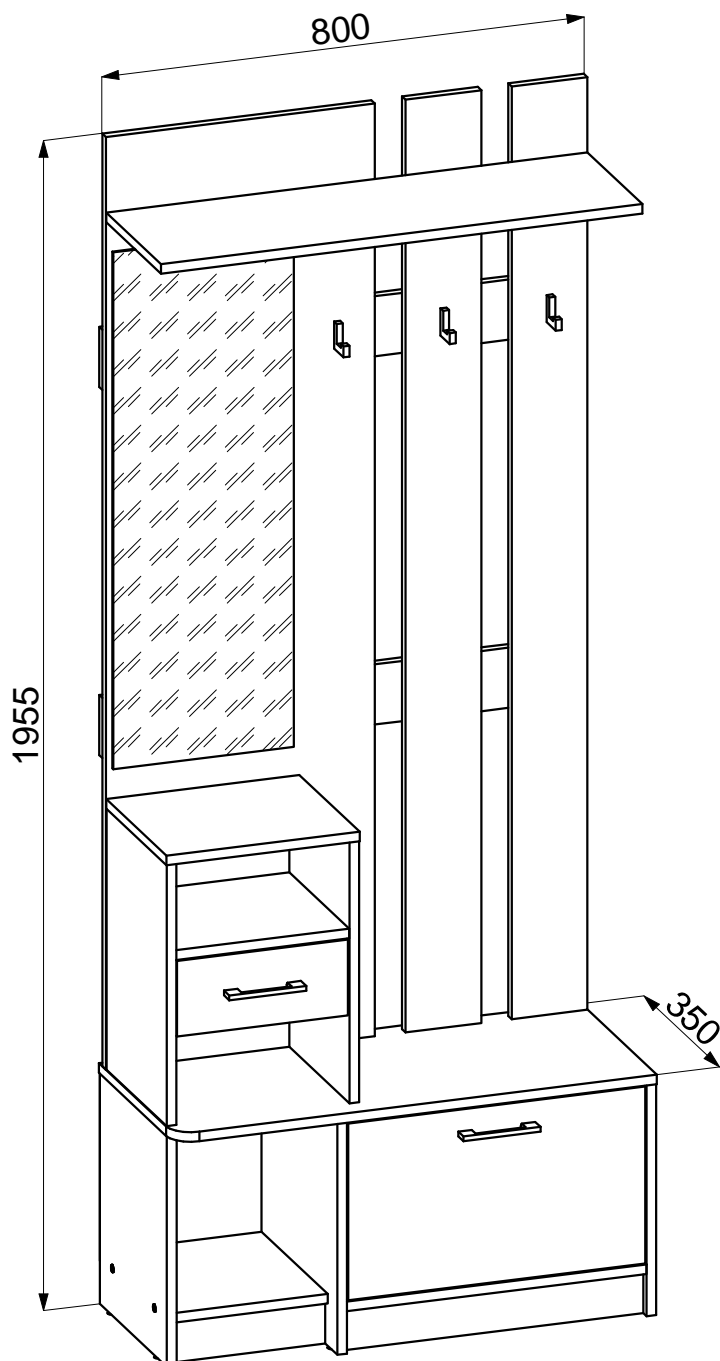

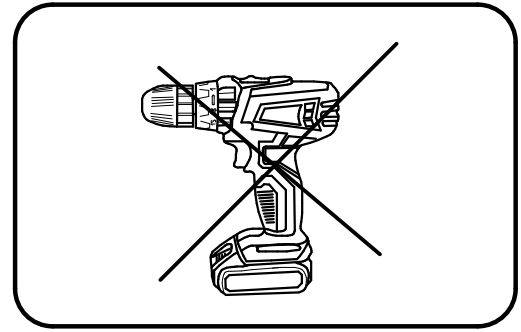

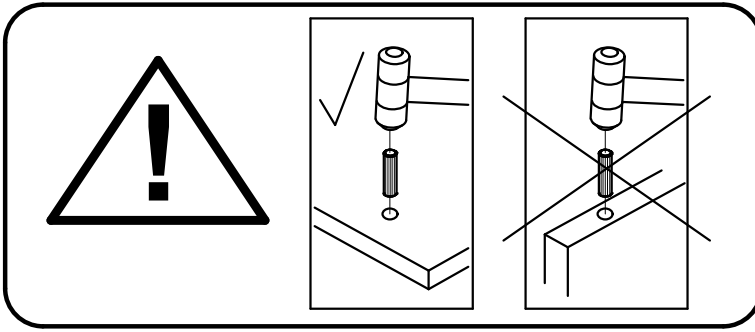





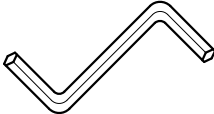
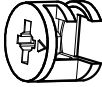
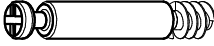



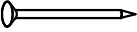

Портманто Диас



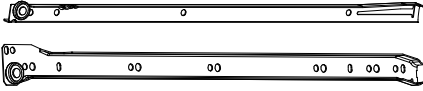
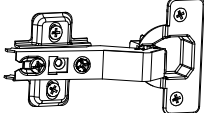



 Ø6,3x50 mm A1 x 31	 Ø12 mm A2 x 31	 4 mm A3 x 1	 Ø15x12 mm B1 x 9	 Ø5x44 mm B2 x 9
 Ø20 mm B3 x 9	 Ø3x16 mm D1 x 18	 Ø4x16 mm D2 x 14	 Ø4x30 mm D3 x 10	 Ø4,2x32 mm D4 x 4
 Ø4x25 mm D5 x 6	 Ø1,6x25 mm F x 55	 Ø8x36 mm G x 32	 H x 2	 Ø5x16 mm L x 6
 K x 1		 M x 2	 Ø15 mm N x 6	 V x 3
 X x 2				

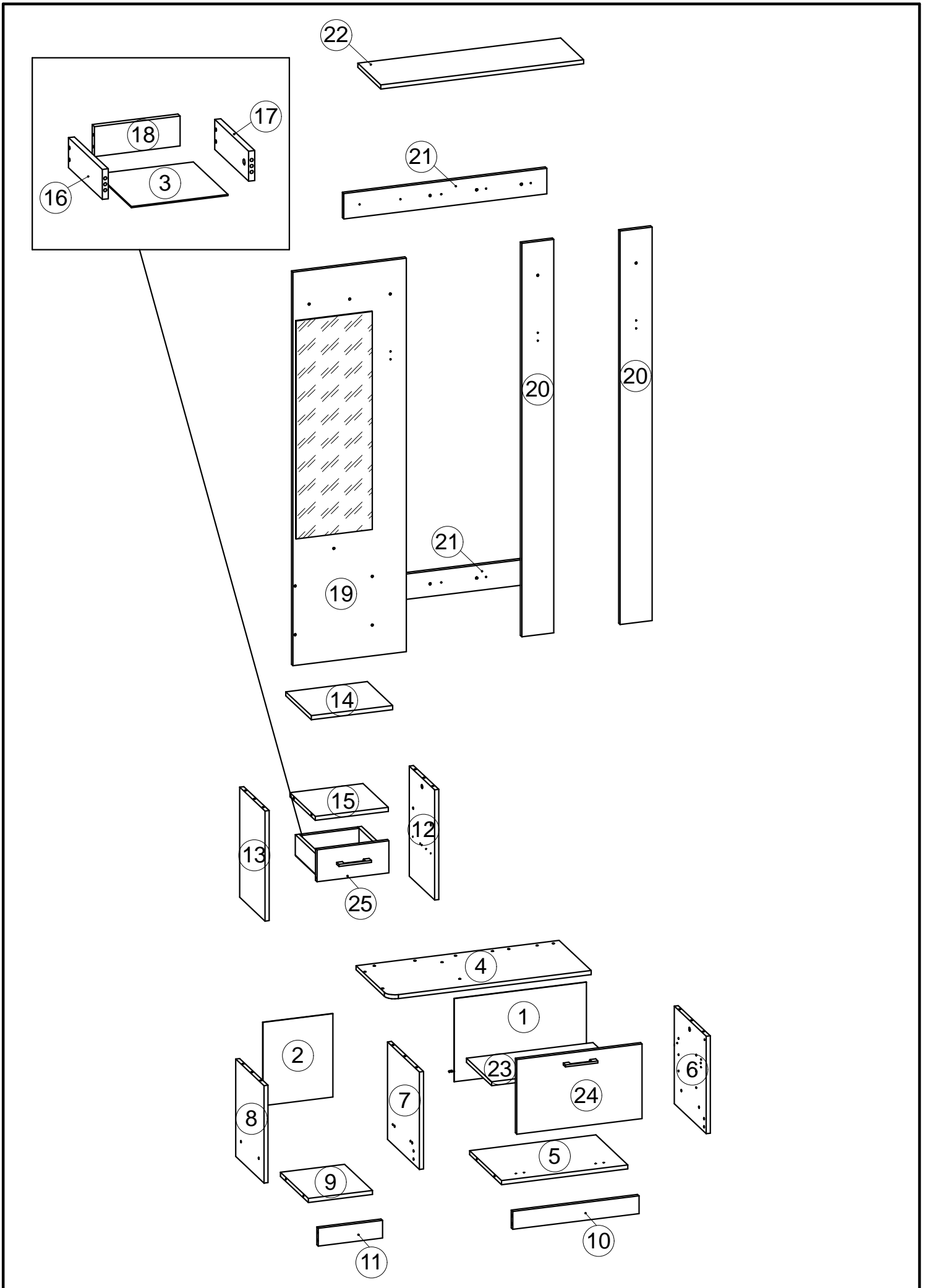

Box 1 / 3

498x345x16 mm 253x301x16 mm 70x253x16 mm 434x274x16 mm 434x274x16 mm 288x273x16 mm

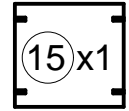
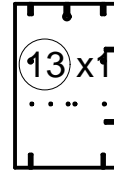
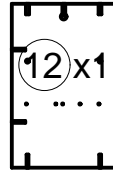
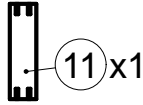
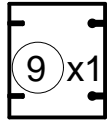
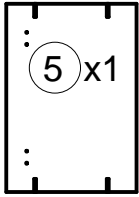

293x493x16 mm

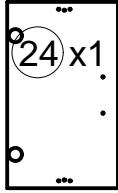

250x80x16 mm

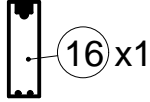

250x80x16 mm

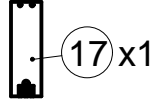

230x80x16 mm

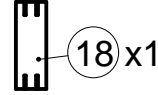

498x270x16 mm

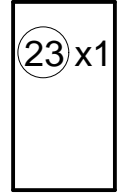

Fittings & Tools

Box 2 / 3

800x347x16 mm

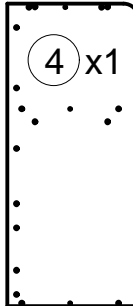

799x250x16 mm

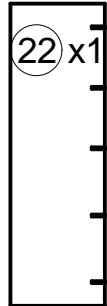

70x498x16 mm

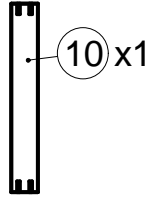

384x306x16 mm

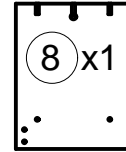

328x521x3 mm

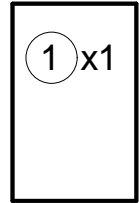

384x346x16 mm

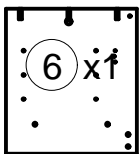

321x275x16 mm

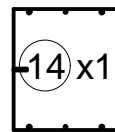

384x346x16 mm

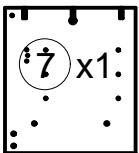

125x283x16 mm

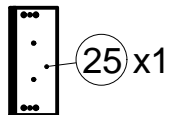

328x276x3 mm

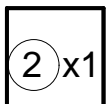

260x256x3 mm

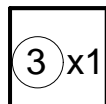

Box 3 / 3

799x99x16 mm



1550x125x16 mm



1550x446x16 mm

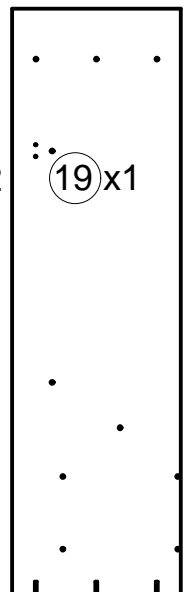

1

D5 x 2 G x 2 V x 1

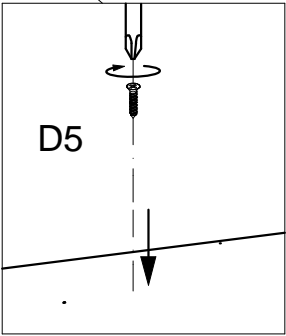
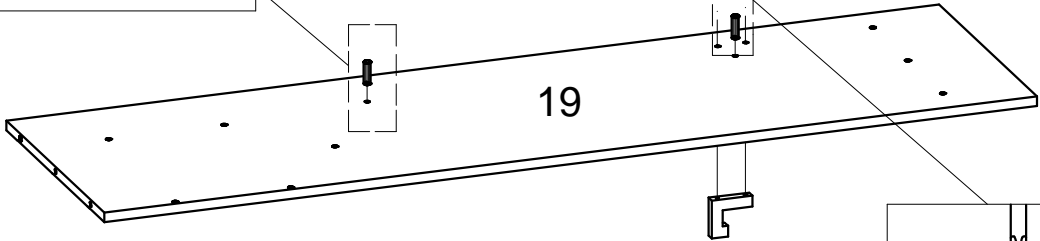
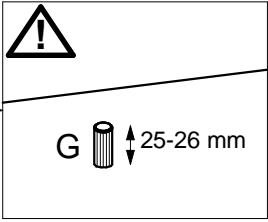
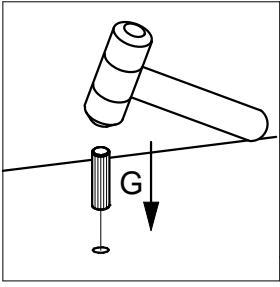
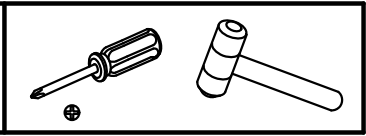

2

D5 x 4 G x 4 V x 2

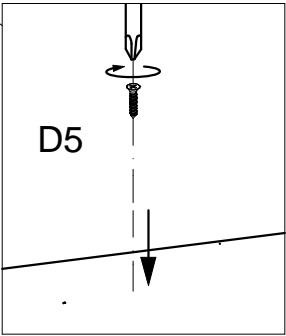
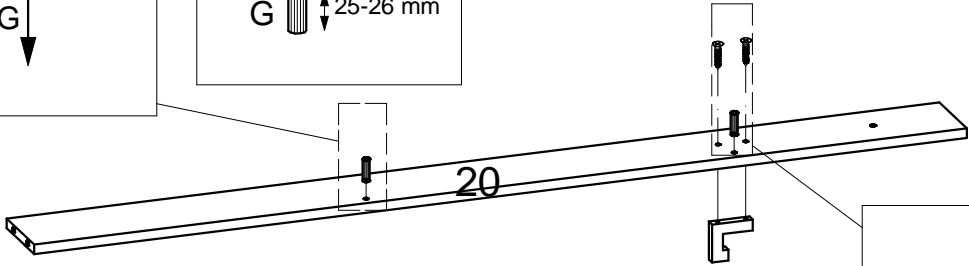
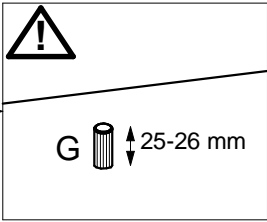
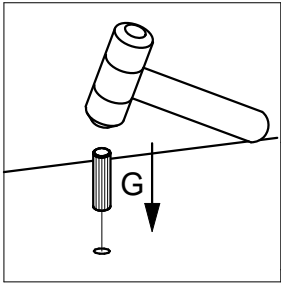
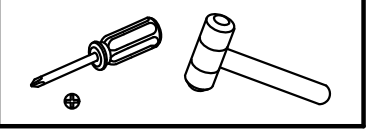

x 2

3

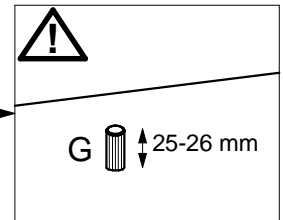
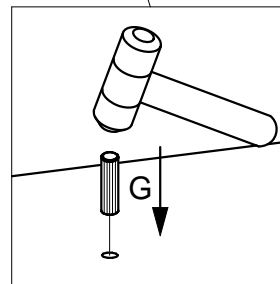
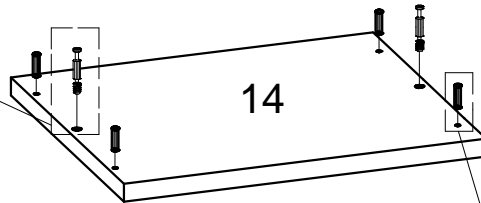
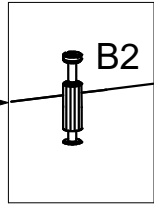
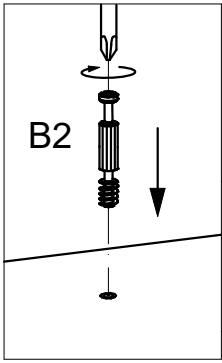
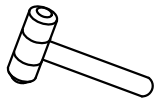
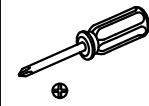
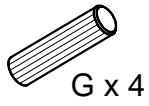
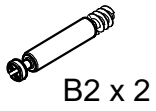

4

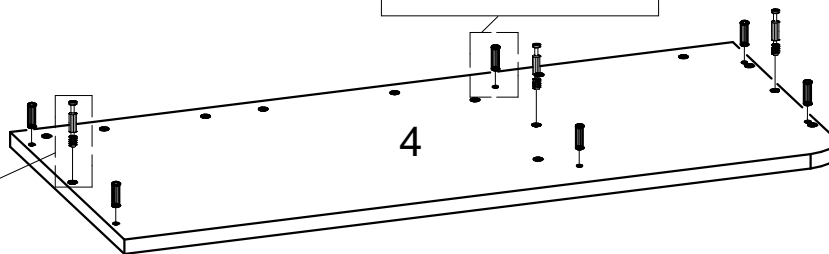
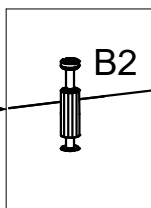
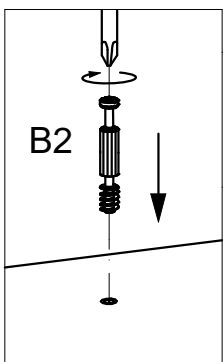
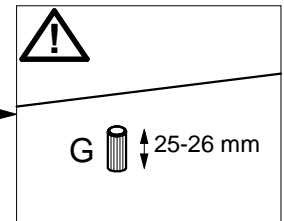
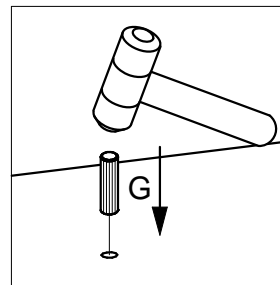
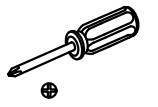
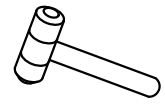
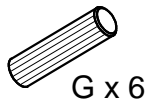
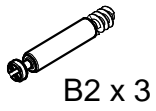

5



B1 x 2



D2 x 4



M.1 x 2

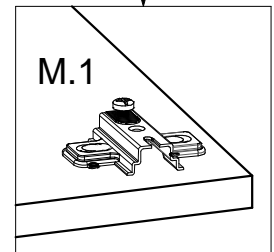
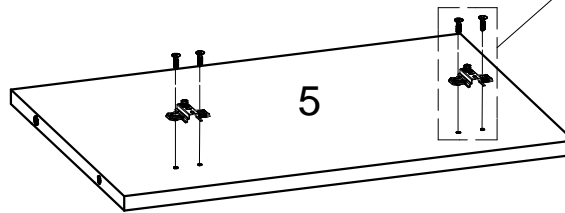
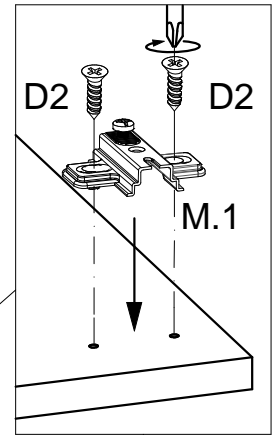
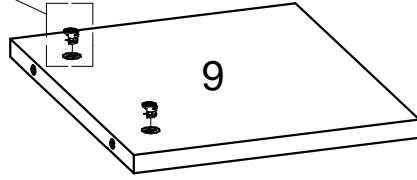
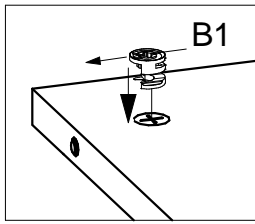
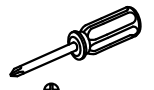

6



B1 x 1



G x 2



L x 3

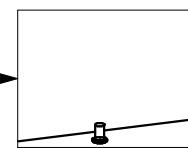
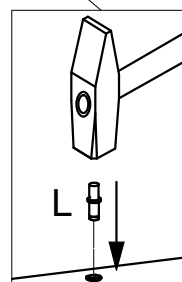
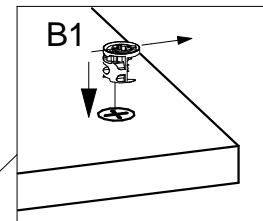
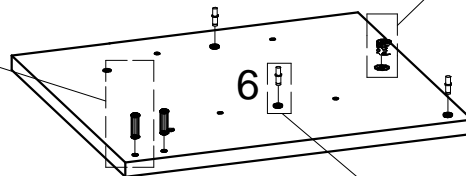
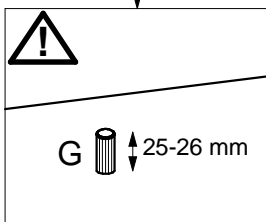
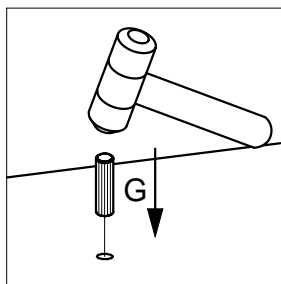
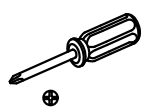
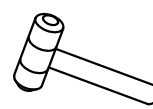
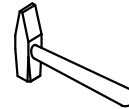

7



B1 x 1



G x 2

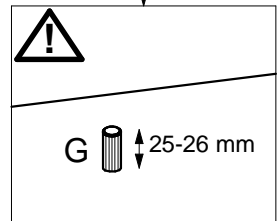
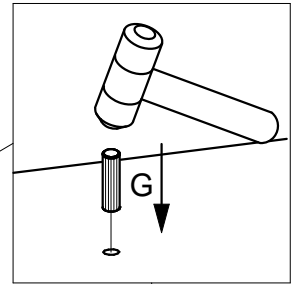
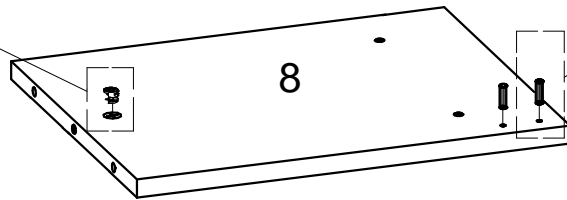
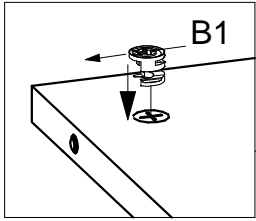
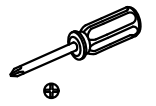
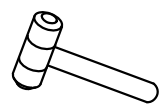

8



B1 x 1



B2 x 2



G x 4



L x 3

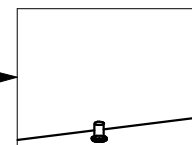
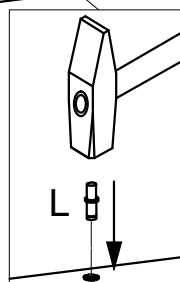
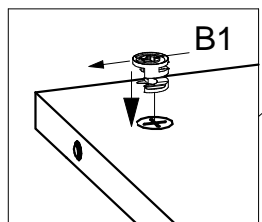
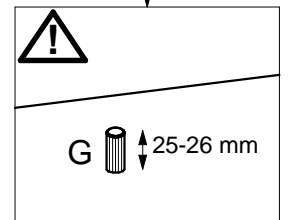
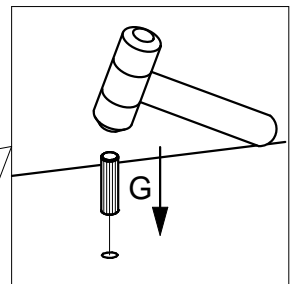
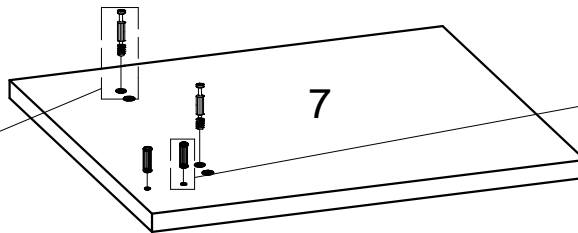
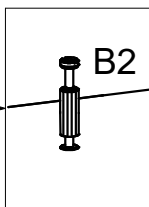
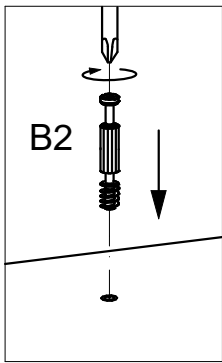
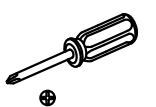
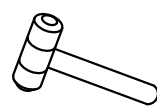
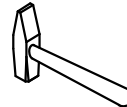

9



B1 x 1



D1 x 3



G x 2



K1 x 1

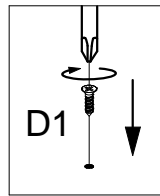
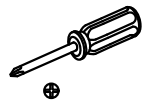
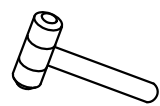

D1

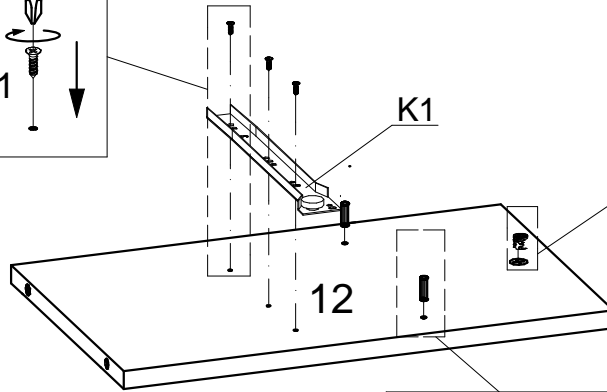

K1

12

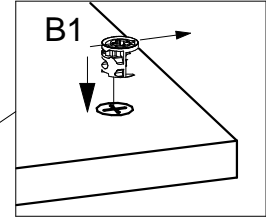

B1

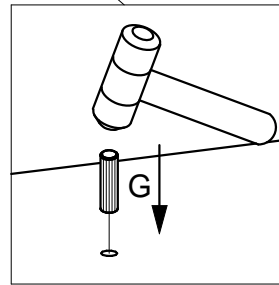

G

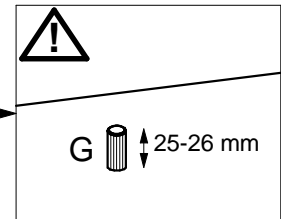

G

25-26 mm

10



B1 x 1



D1 x 3



G x 2

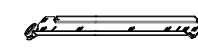

K2 x 1

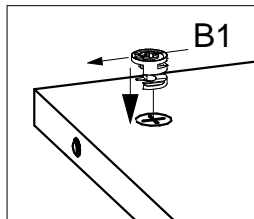
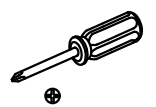
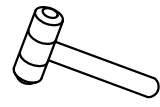

B1

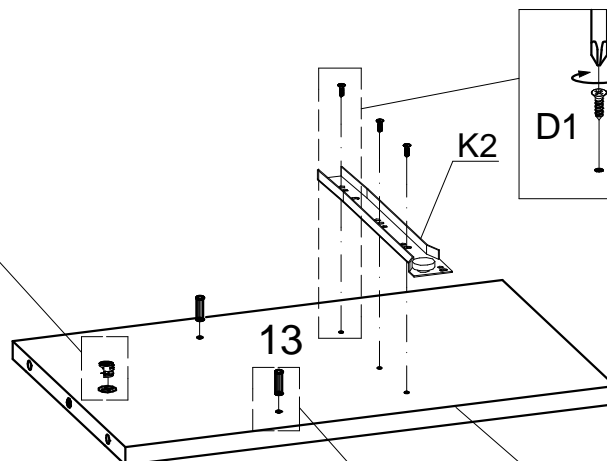

K2

13

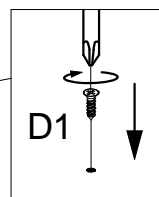

D1

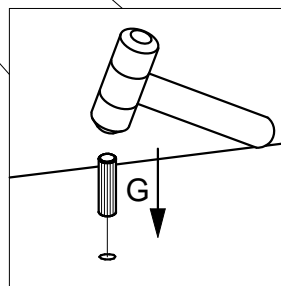

G

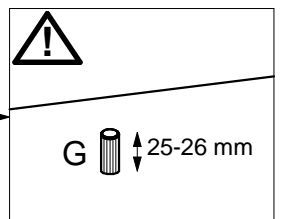

G

25-26 mm

11

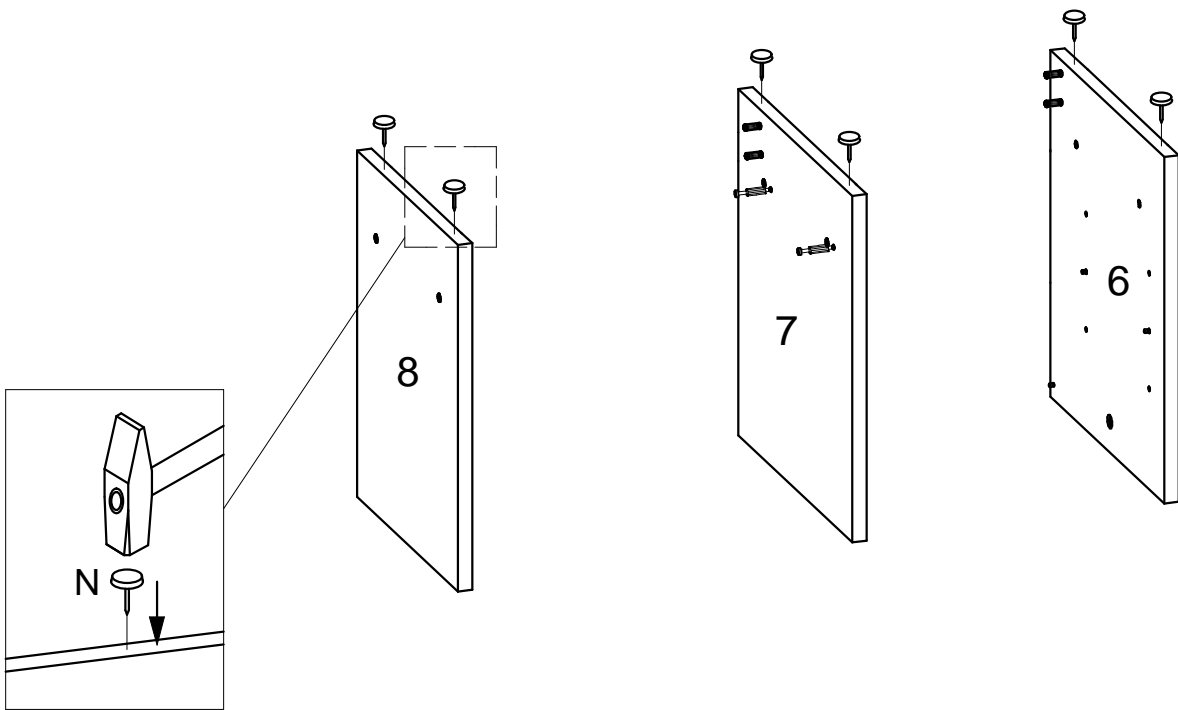
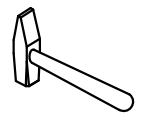

12



D2 x 4

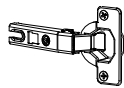

M.2 x 2

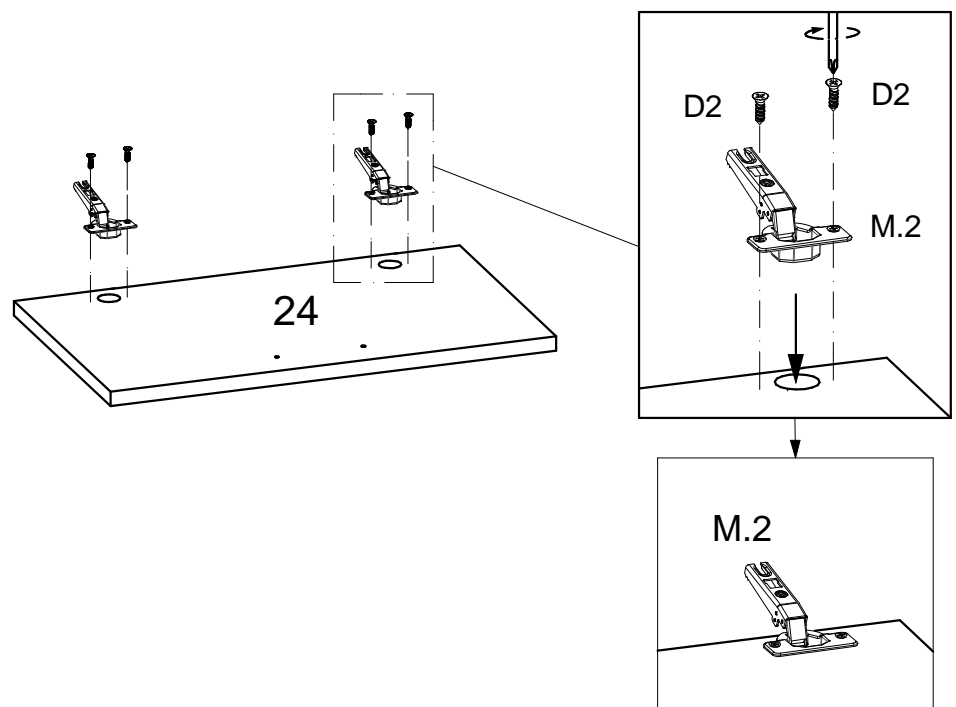
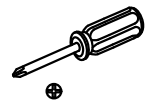

13



A1 x 4



A2 x 4



A3 x 1

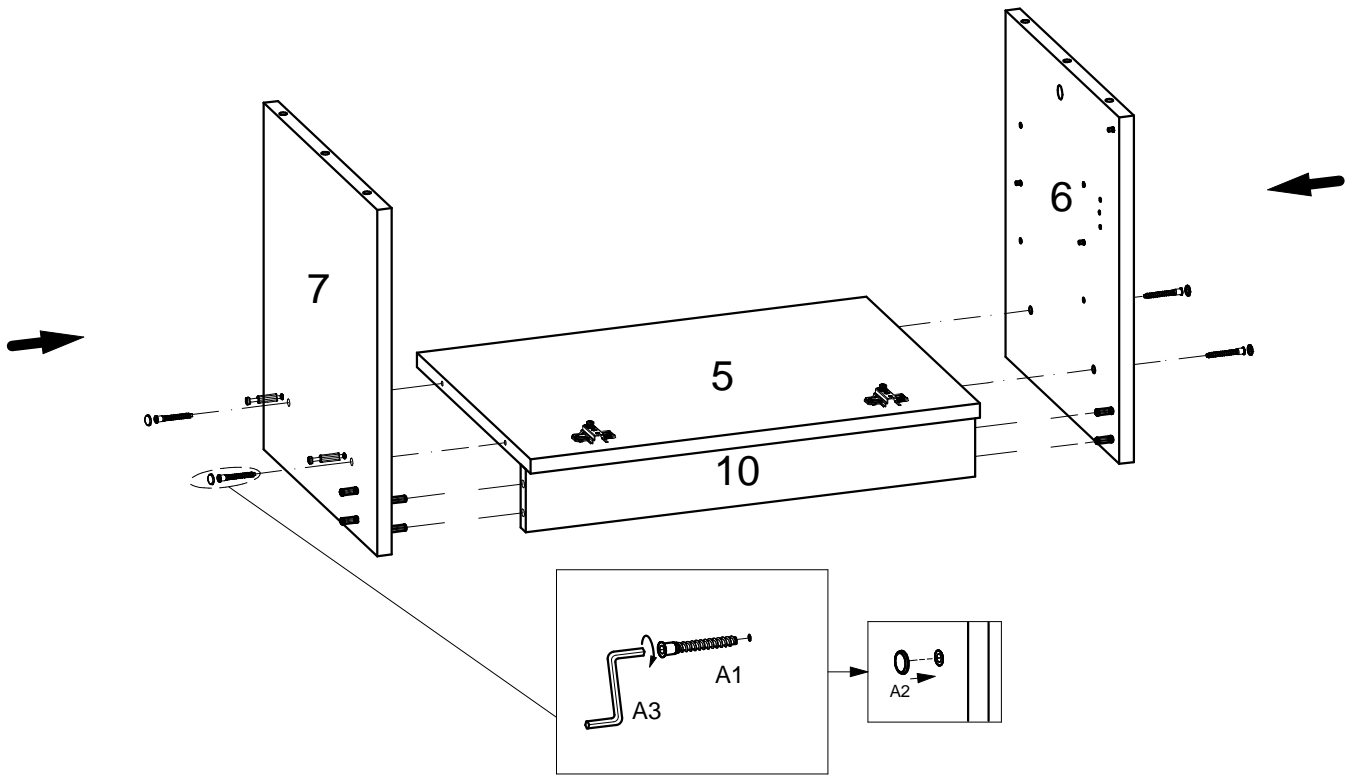
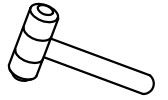

14



A1 x 2



A2 x 2



A3 x 1



B3 x 2

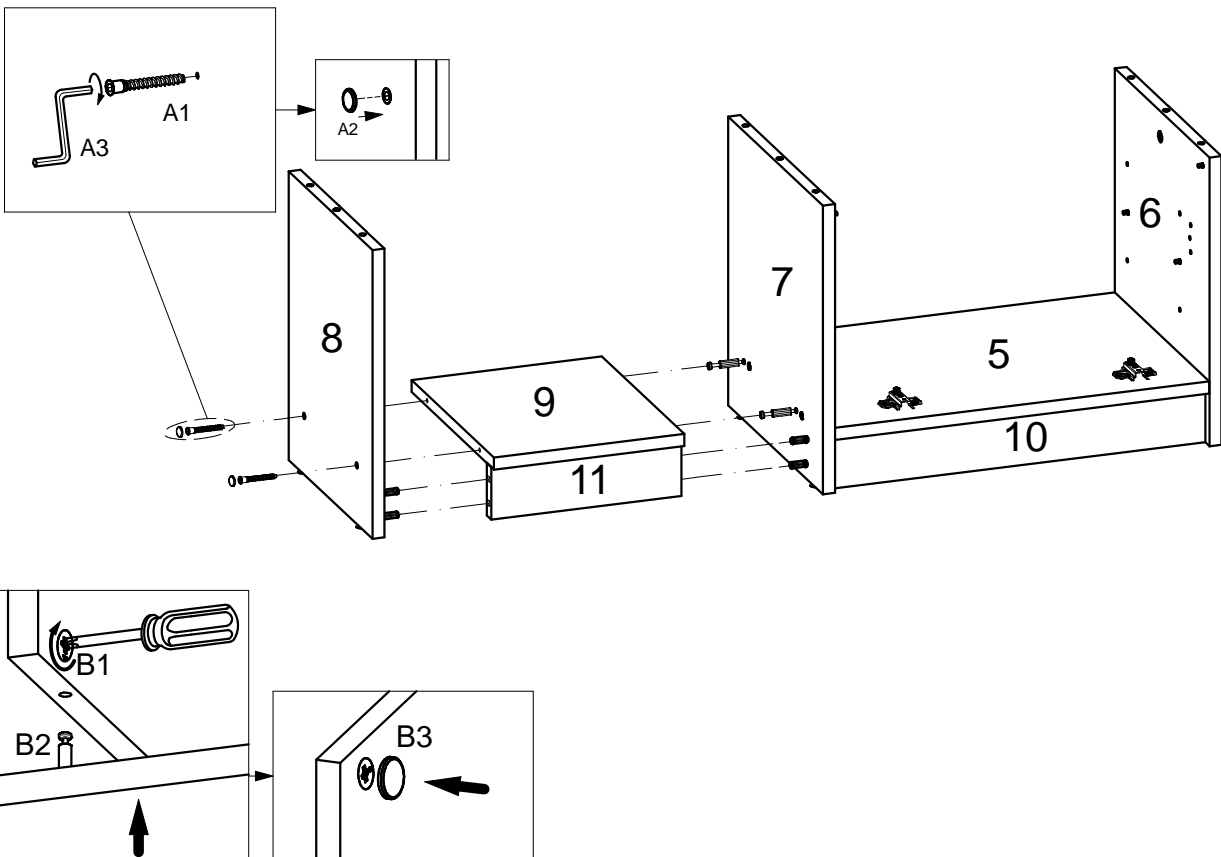
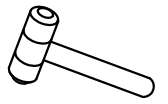
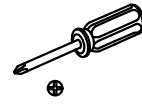

15

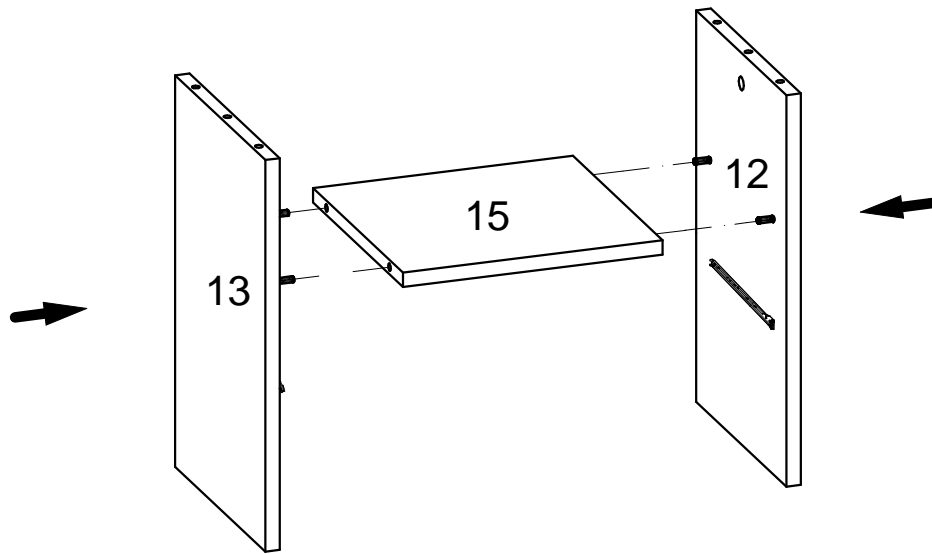
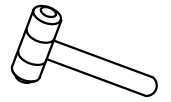

16



B3 x 2

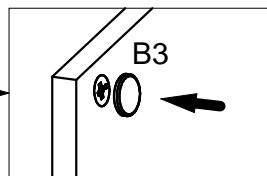
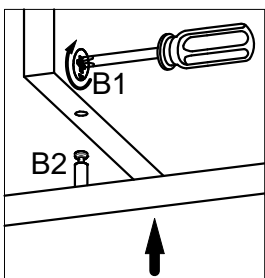
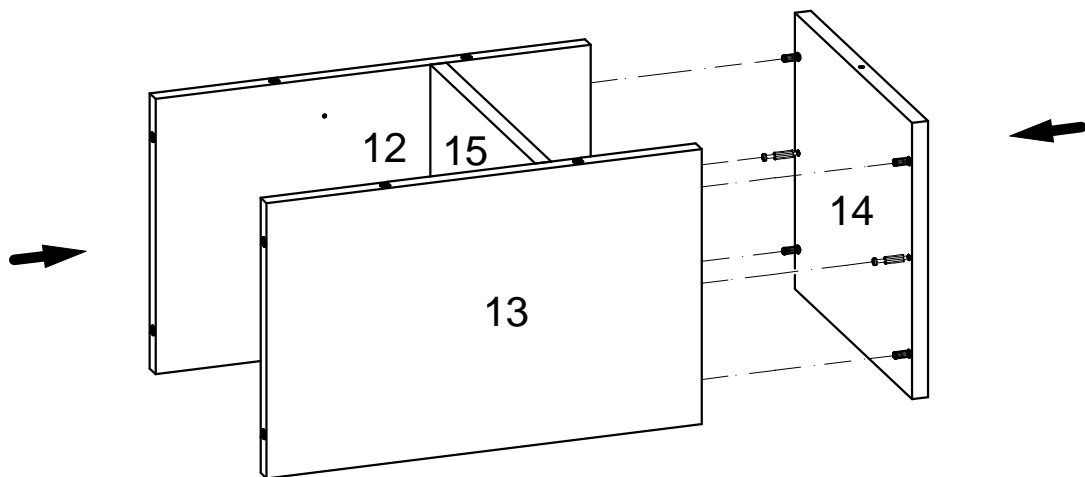
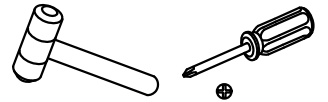

17

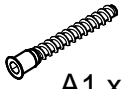

A1 x 10



A2 x 10



A3 x 1



D3 x 10

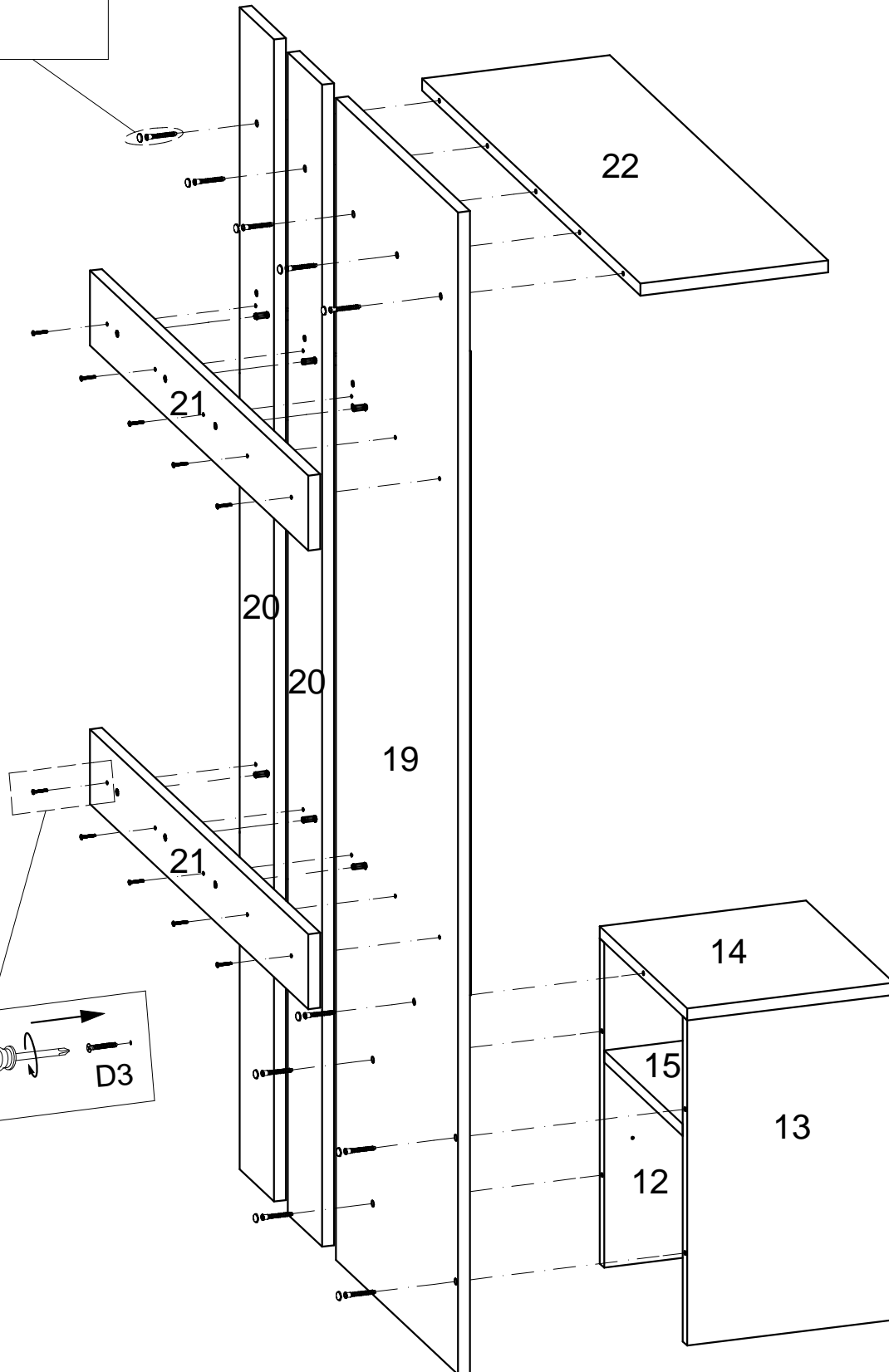
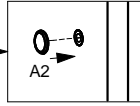
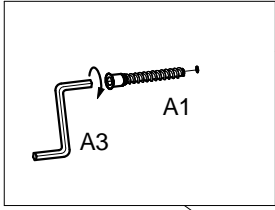
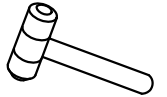
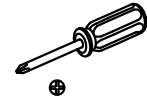

18

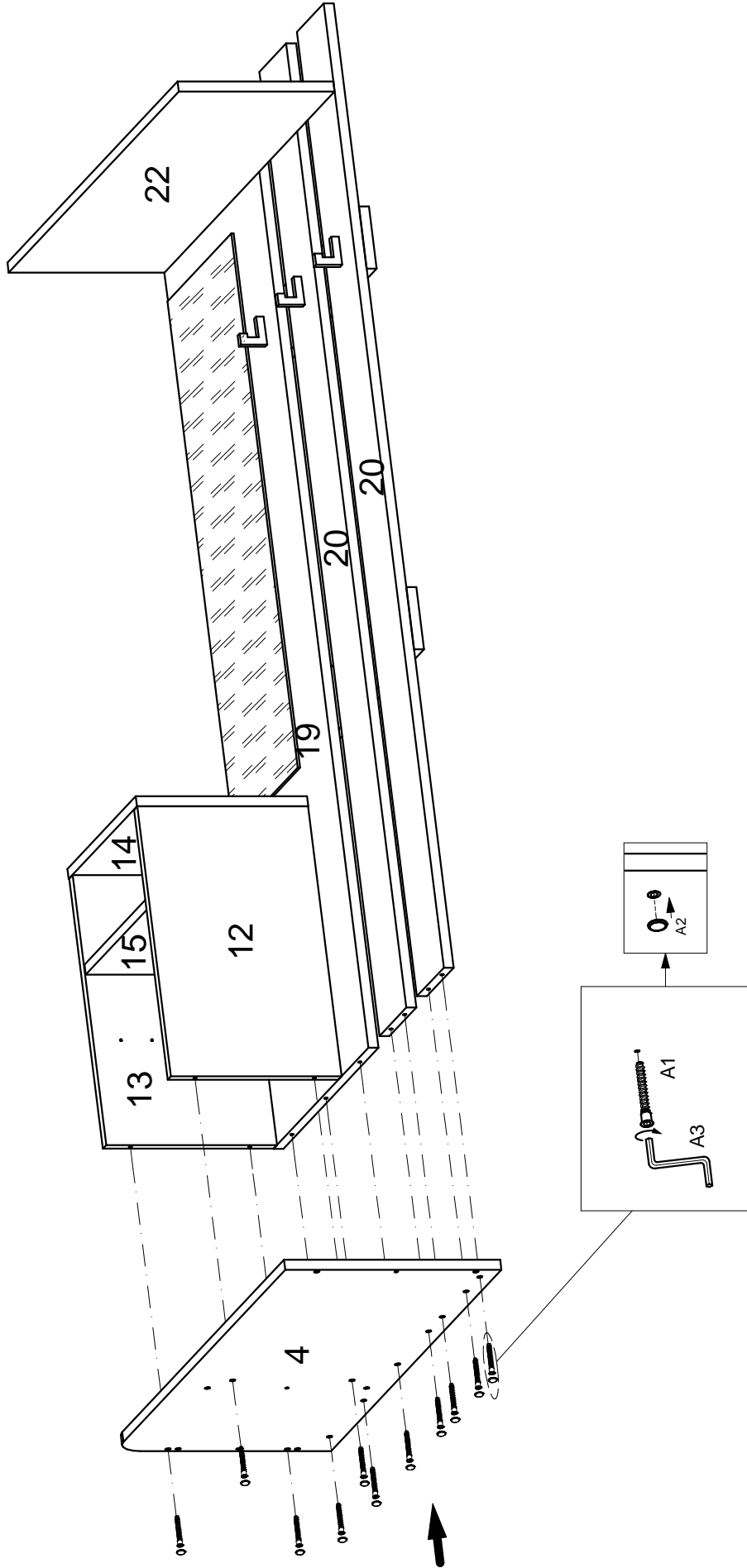

19



B3 x 3

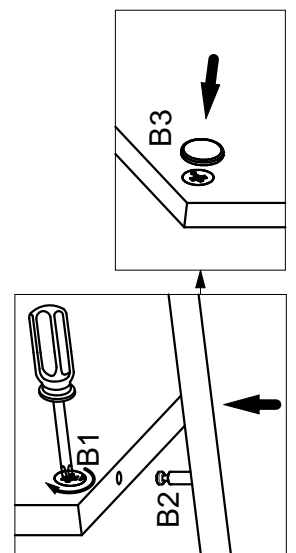
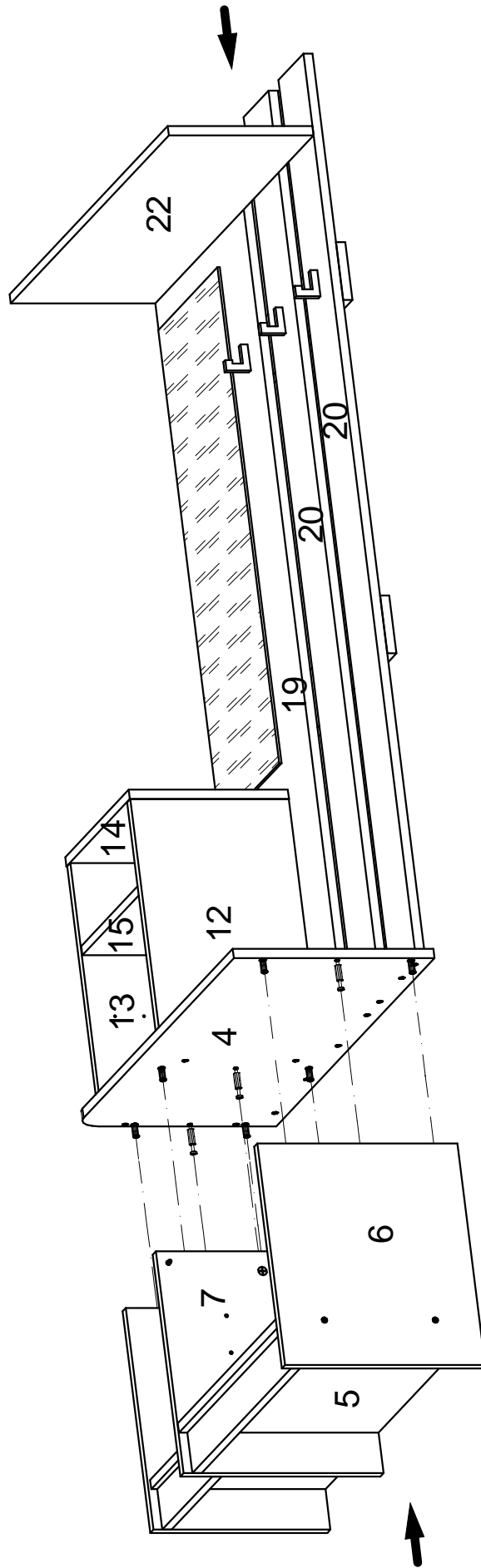
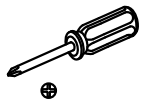
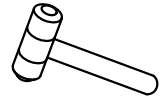

20

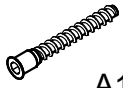

A1 x 4



A2 x 4



A3 x 1



B1 x 2

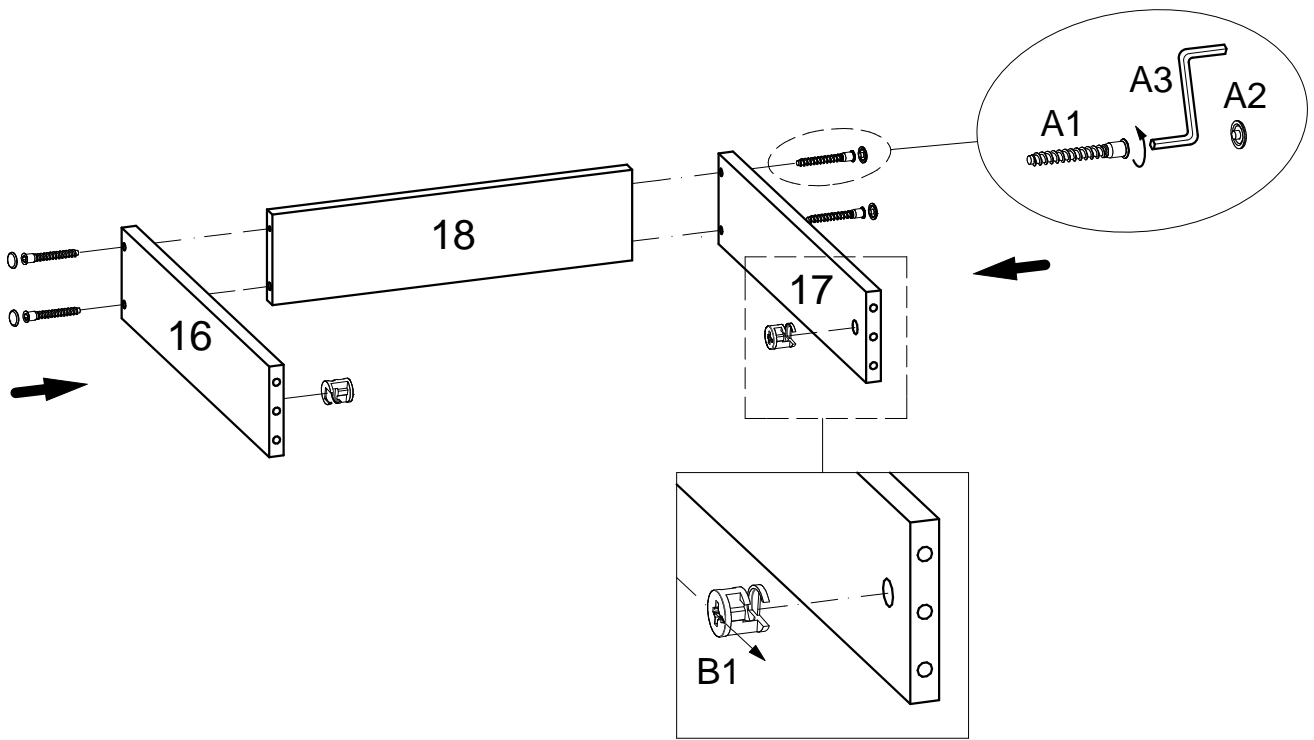
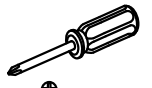

21

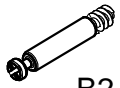

B2 x 2



B3 x 2



D4 x 2

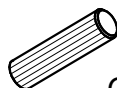

G x 4



H x 1

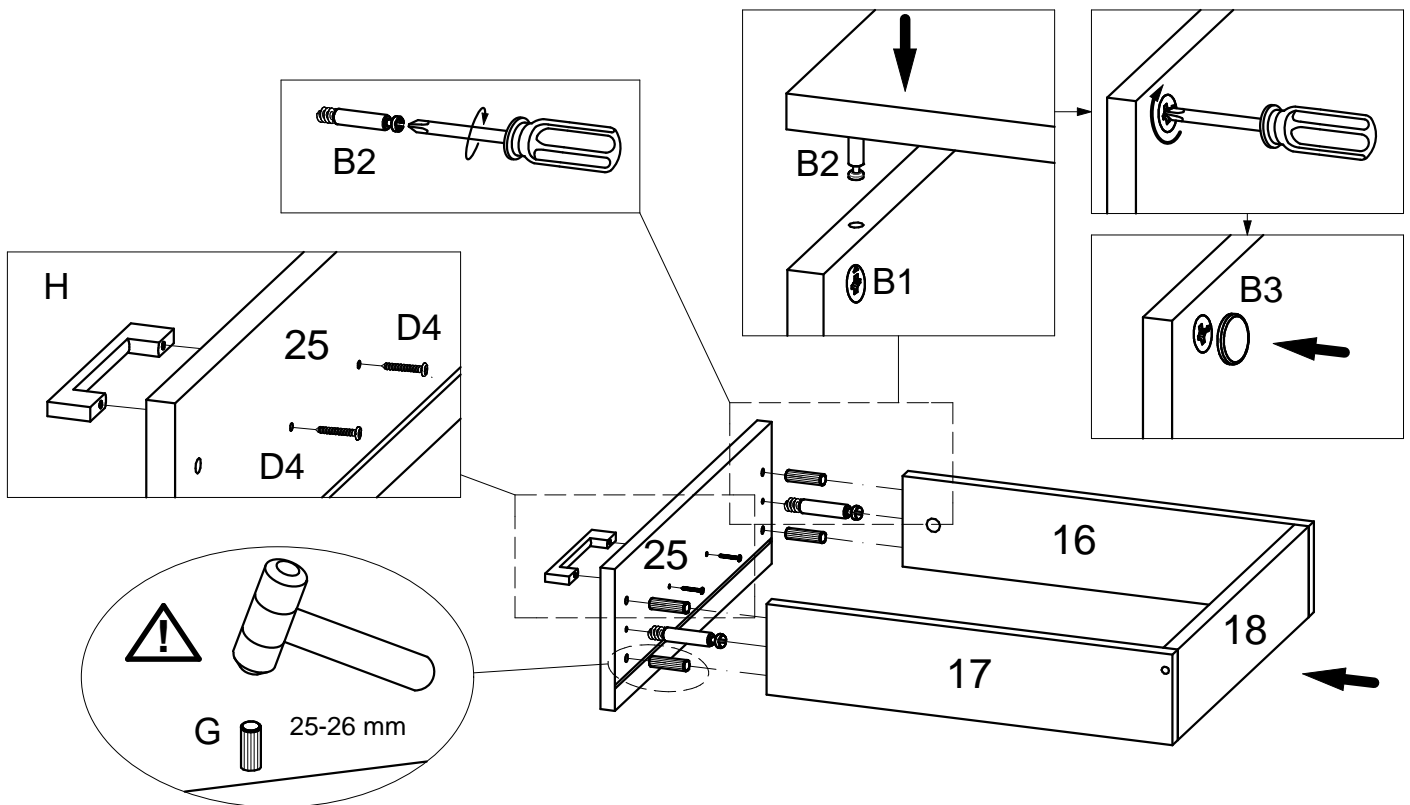
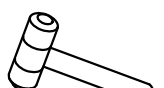
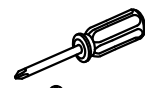

22

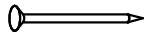

F x 22

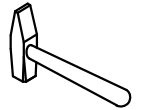

 $XX=YY\cong 90^\circ$

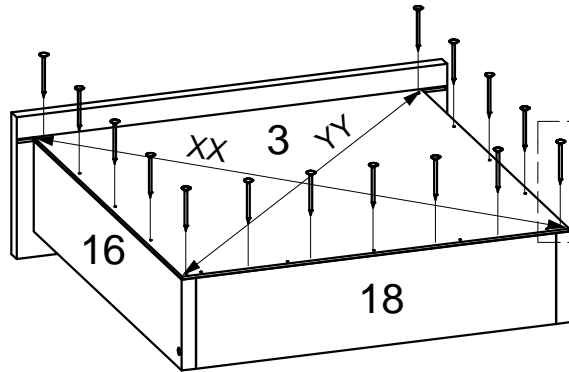
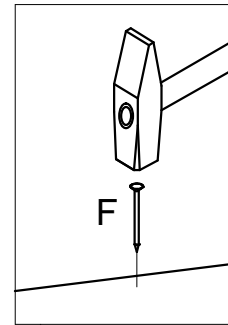

23



D2 x 6

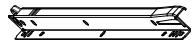

K3 x 1

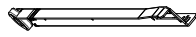

K4 x 1

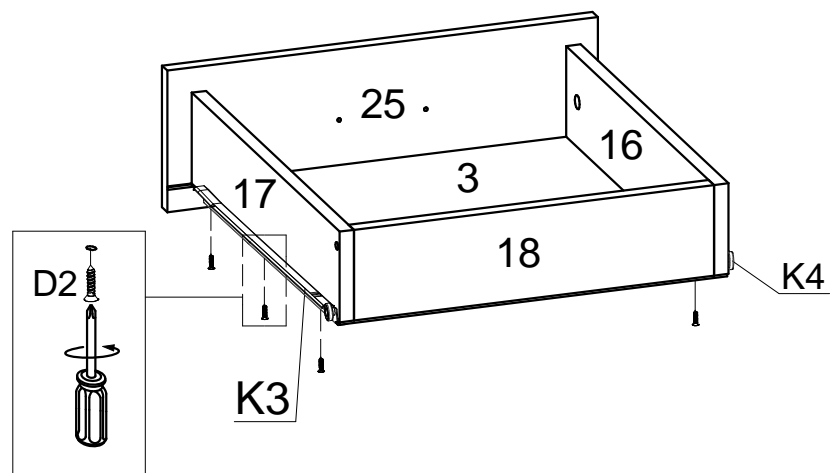
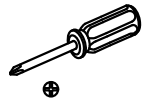

25



D1 x 12



D4 x 2



H x 1



X x 2

